

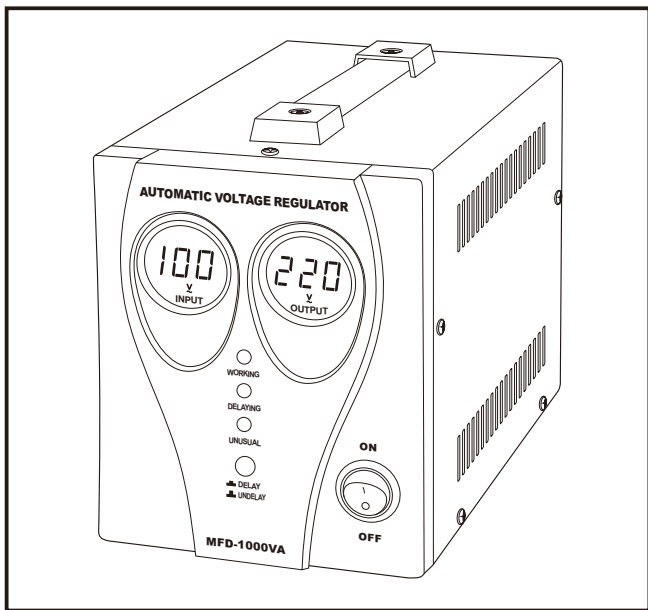

MICROPROCESSOR CONTROL (CPU)

AUTOMATIC VOLTAGE REGULATOR

HIGH & LOW VOLTAGE PROTECTION



Instruction Manual

Please read user manual carefully before use.

1. FEATURES

- Microprocessor Control (CPU)
- Wide Range Voltage Regulation
- Automatically Executes Protection, When Protection Finished, Goes Off.
- High Voltage Protection: Yes
- Low Voltage Protection: Yes
- Overload Protection: Yes (3KVA,5KVA)
- High Temperature Protection: Yes
- Circuit Protection: Circuit Breaker
- Smart Cooling System: Yes (3KVA,5KVA)

2. DESCRIPTION

FIG 1

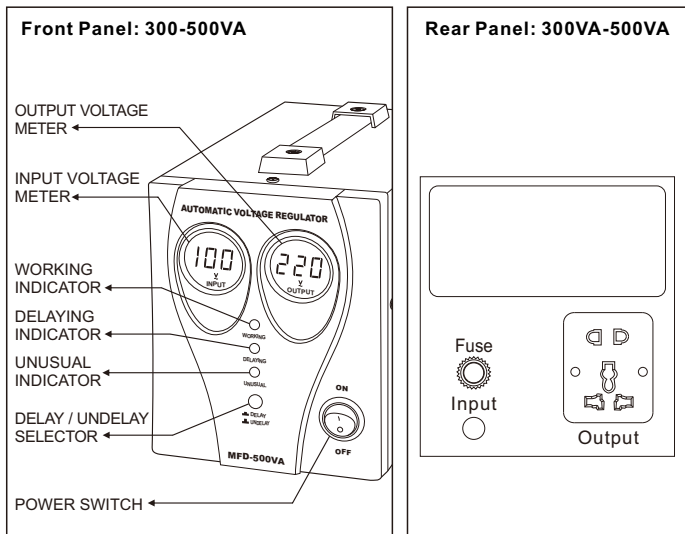
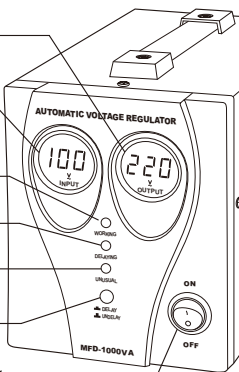
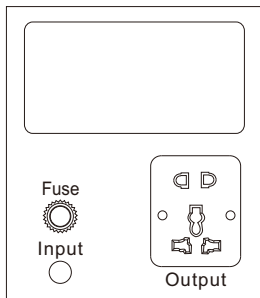
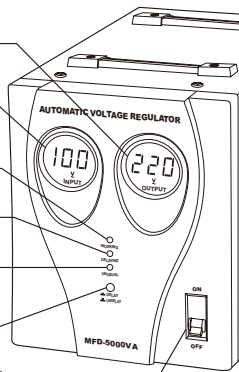
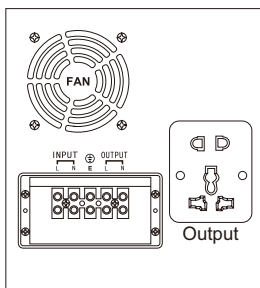

FIG 2**Front Panel: 1000VA-2000VA**OUTPUT VOLTAGE
METER ←INPUT VOLTAGE
METER ←WORKING
INDICATOR ←DELAYING
INDICATOR ←UNUSUAL
INDICATOR ←DELAY / UNDELAY
SELECTOR ←

POWER SWITCH ←

**Rear Panel: 1000VA-2000VA****FIG 3****Front Panel: 3000VA-5000VA**OUTPUT VOLTAGE
METER ←INPUT VOLTAGE
METER ←WORKING
INDICATOR ←DELAYING
INDICATOR ←UNUSUAL
INDICATOR ←DELAY / UNDELAY
SELECTOR ←

POWER SWITCH ←

**Rear Panel: 3000VA-5000VA**

3. INDICATING SIGN



WORKING

WHEN THE GREEN INDICATOR IS LIGHTING. THE REGULATOR IS WORKING.



DELAYING

WHEN ORANGE INDICATOR IS FLASHING EVERY ONE SECOND, THE SYSTEM IS TURNING INTO DELAYING STATE, AND THE REGULATOR HAS NO OUTPUT. AFTER DELAY, ORANGE INDICATOR WILL EXTINGUISH AND THE REGULATOR RESUME OUTPUT.



UNUSUAL

WHEN OUTPUT VOLTAGE OF AVR IS HIGHER THAN SET VALUE, THE SYSTEM ENTER INTO HIGH & LOW VOLTAGE PROTECTION, UNUSUAL RED LED FLASHES EVERY ONE SECOND AND OUTPUT GOES OFF. WHEN OUTPUT VOLTAGE OF AVR IS UNDER SET VALUE, THE SYSTEM ENTER NORMAL WORKING STATE, UNUSUAL RED LED EXTINGUISHES.

WHEN TEMPERATURE OF AVR IS HIGHER THAN SET TEMPERATURE, THE SYSTEM ENTER INTO TEMPERATURE PROTECTION, UNUSUAL RED LED FLASHES EVERY ONE SECOND AND OUTPUT GOES OFF. WHEN TEMPERATURE OF AVR IS LOWER THAN SET TEMPERATURE, THE SYSTEM ENTER INTO NORMAL WORKING STATE, UNUSUAL RED LED EXTINGUISHES

NOTE: Indication for overheating is not equipped in standard configuration. This function should be effective only after users notify manufacturer in advance.

4. LED INDICATOR ILLUSTRATION

LED Indicator Illustration			
CONDITION	WORKING-G	DELAYING-Y	UNUSUAL-R
Power Off	—	—	—
Working	⊗	—	—
Delay State	⊗	☆	—
Output high voltage protection	⊗	—	☆
Output low voltage protection	⊗	—	☆
High temperature protection	⊗	—	☆

NOTE: ⊗ : CONTINUOUSLY ILLUMINATE

☆ : FLASH

— : EXTINGUISH

NOTE: Indication for overheating is not equipped in standard configuration. This function should be effective only after users notify manufacturer in advance.

5. LED DIGITAL DISPLAY INDICATOR ILLUSTRATION

LED Digital Display Indicator Illustration		
CONDITION	INPUT DISPLAY INDICATOR	OUTPUT DISPLAY INDICATOR
Power Off	Extinguish	Extinguish
Working	Input Voltage	Output Voltage
Delay state	Voltage at low-voltage protection (selective)	Countdown (selective)
Output high voltage protection	“HHH” (Flash)	“U-P”
Output low voltage protection	“LLL” (Flash)	“U-P”
High temperature protection	“FOH”	“F-P”
Overload protection	“LOH”	“L-P”

6. OPERATION

- Before use, please make sure the voltage and power of the appliance are accord with the labeled power and specification of the unit to avoid any damage.
- Please connect the appliance before turning on the unit. Switch on appliance after you make sure the unit is working normally with output voltage.
- When connecting the electrical appliance with motor or compressor, such as drill, air-conditioner and so on, to the automatic voltage regulator, please make sure that the power rating of the automatic voltage regulator is at least 3 times of the power rating of the electrical appliance, so that it can work smoothly, because the starting up power is much beyond of the power rating of the electrical appliance.
- Output Delay: Delay time 6 seconds (DEFAULTED) and 120 seconds (MANUAL SWITCH) are alternative.

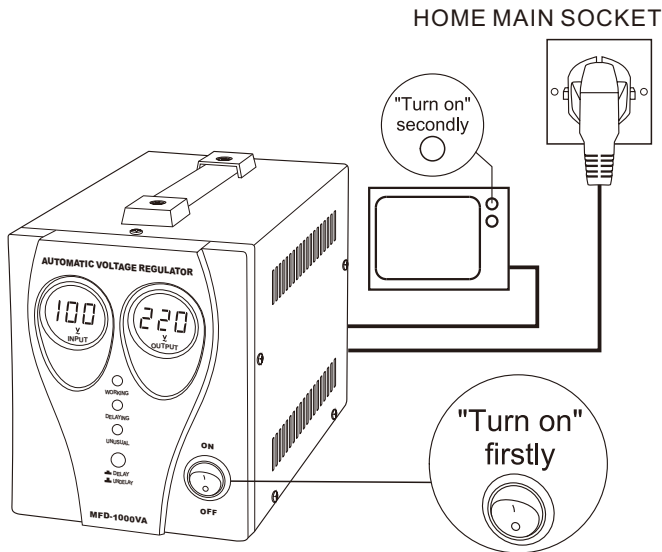

NOTE: DELAY only takes effect when the system is restarted into normal.

7. LOW & HIGH VOLTAGE PROTECTION

- When output voltage is lower or higher than labeled voltage, AVR will turn into self-protection state automatically, the UNUSUAL RED indicator flashes every one second and output voltage will be cut off.
- When output voltage comply with labeled voltage, AVR will go into automatic recovering state, the UNUSUAL RED indicator extinguishes. Then DELAYING ORANGE indicator flashes every one second, the system goes into delaying state. After delay, DELAYING ORANGE indicator extinguishes and output voltage resume .

8. THERMAL PROTECTION

- When the temperature of the transformer exceeds $130^{\circ}\text{C} \pm 5\%$, the system will automatically turn into self-protection state, UNUSUAL RED indicator will flash every one second and output voltage shut down. While temperature is lower $70^{\circ}\text{C} \pm 5\%$, the system will recover automatically. UNUSUAL RED indicator will extinguish, and output resume.

NOTE: No overheating Protection is equipped in standard configuration, users should notify manufacturer and take special order if this function is required.

9. OVERLOAD PROTECTION

- When avr is overload, the system will turn into self-protection, red led indicator will illuminate continuously and there is no output. To resume the output, you should lessen the load and then restart the unit.

NOTE: This function only suitable for 3KVA / 5KVA

NOTE: No overload Protection is equipped in standard configuration, users should notify manufacturer and take special order if this function is required.

10. WITH COOLING FAN

- When the temperature of transformer exceeded $90^{\circ}\text{C} \pm 5\%$, the cooling fan will switch on automatically to low down inside temperature and will stop working while the temperature comes down.

NOTE: This function only suitable for 3KVA , 5KVA

11. OUTPUT CAPACITY

- The automatic voltage regulator will switch off automatically if the total wattage of the electrical appliances exceed the automatic voltage regulator output capacity.

- If this voltage is in the range of 190-250V, the regulator provides the 100% listed maximum output power. maximum output power will change as the curve shown below.

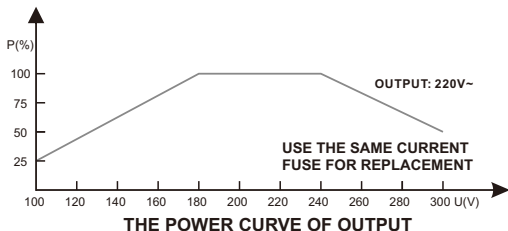

12. GROUNDING CONNECTION

WARNING: BEFORE USING THIS AUTOMATIC VOLTAGE REGULATOR YOU MUST PROVIDE A GROUND CONNECTION TO THE AUTOMATIC VOLTAGE REGULATOR.

- On the rear panel of the automatic voltage regulator there is a terminal fitted with a nut. This terminal is connected to the case of the automatic voltage regulator and also to the earth terminal of the AC output socket. The use of this terminal will depend on your particular installation. In any installation, heavy duty, green-insulated wire should be used for this connection.

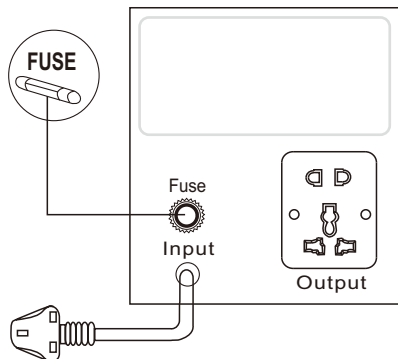

Model: 500VA, 1000VA, 1500VA, 2000VA

- In a stationary land based installation, the earth terminal should be connected to a metal earthing stake driven into the ground to a depth of 1.2m or more.

Model: 3KVA, 5KVA

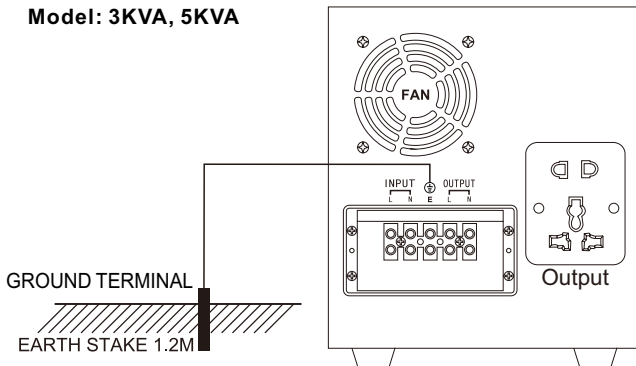

NOTE: The earth terminal of the AC outlet is connected to the neutral terminal. This is the same as a standard household power point where the neutral line is bonded to earth and there is normally no voltage between them.

13. CAUTION

- In case of trouble with the AC output, e.g. short-circuit, overload, etc... the protection circuit will automatically cut off the output.
In such cases:
 - (A) switch off the power at once
 - (B) disconnect all units
 - (C) check the connected devices
 - (D) use the unit again unless the problems concerning the connected devices have been solved
- When in use for a prolonged period of time, the AC output may suddenly be cut off although the input voltage normal, This may be caused by excessive temperatures. If this happens. Please proceed as follows:
 - (A) Switch off the automatic voltage regulator at once
 - (B) Disconnect some of the appliances or wait until the automatic voltage regulator cools off
 - (C) Switch the automatic voltage regulator back on

- Always keep the automatic voltage regulator in an environment which is:
 - (A) Well-ventilated
 - (B) Not exposed to direct sunlight or any other heat source
 - (C) Inaccessible to children
 - (D) Safe from water/moisture, oil or grease
 - (E) Safe from any flammable substance

WARNING: DO NOT DISASSEMBLE THE UNIT. HAZARDOUS VOLTAGE! DANGER!
PLEASE RETURN TO THE DEALER IF YOU FIND ANY PROBLEM WITH THE UNIT

14. MAINTENANCE

- Very little maintenance is required to keep your automatic voltage regulator operating properly.
- You should clean the exterior of the unit periodically with a damp cloth to prevent accumulation of dust and dirt. At the same time, tighten the screws on the AC input terminals.

15. EXPERT OF PROTECTOR FOR

- Make sure that the total laden power does not exceed the listed maximum output power of the regulator.
Be sure to connect the ground point to the ground for your safety.

Expert of Protector For:

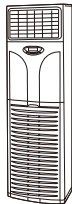
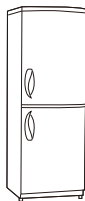
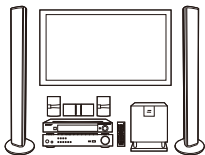
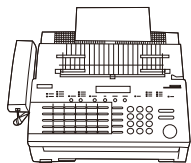
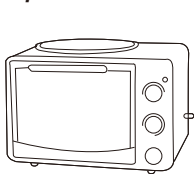

16. SPECIFICATION

P/No.	MFD-500VA	MFD-1000VA	MFD-1500VA	MFD2000VA	MFD-3000VA	MFD-5000VA
Input Voltage	<input type="checkbox"/> 100-260V~	<input type="checkbox"/> 120-260V~	<input type="checkbox"/> 140-260V~	<input type="checkbox"/> 80-140V~		
Output Voltage	<input type="checkbox"/> 220V~	<input type="checkbox"/> 230V~	<input type="checkbox"/> 240V~	<input type="checkbox"/> 110V~	<input type="checkbox"/> 115V~	
Output Power	500VA	1000VA	1500VA	2000VA	3000VA	5000VA
Frequency	50/60Hz					
Output Precision	+/-10%					
High Voltage Protection	Circuit Protection					
Low Voltage Protection	Circuit Protection					
Overload Protection					Circuit Protection	
High Output Voltage Protection	255V~					
Input Fuse	250V AC, T5.0A	250V AC, T8.0A	250V AC, T10A	250V AC, T15A	16A	25A
Fuse Size	5x20mm	5x20mm	5x20mm	5x20mm	Circuit breaker	Circuit breaker
Delay Time	6 secs. / 120 secs.					
Thermal Protection	130 °C +/-5%					
Cooling Fan	No	No	No	No	Yes Auto-operation fan (temperature or load)	
Dimension (L x W x H) cm	24.5x11.3x16.5 cm	26.3x12.5x17 cm	28.3x14x19 cm	28.3x14x19 cm	39x21.5x26 cm	39x21.5x26 cm

* specification are subjected to change without prior notice.

CAUTION

- Avoid overloading
Do not use the regulator beyond its maximum power.
- When connected to any appliance with built-in motor compressor, the starting power is generally several times of the appliance's listed power rating. Make sure that the total starting power capacity of all connected appliance does not exceed the listed maximum output power of the regulator. For color TV, calculate it twice as its listed capacity.
- Make sure that the regulator is of the same output voltage and frequency as the appliance's it connected.
- Make sure that the voltage of electrical source is within the listed range of the input voltage of the regulator.
- Always place the regulator in an environment that is:
 - (A) Well ventilated.
 - (B) Not exposed to direct sunlight or heat source.
 - (C) Out of reach from children.
 - (D) Away from water moisture oil or grease.
 - (E) Away from any flammable substance.

